

0.9X0.9X1.2

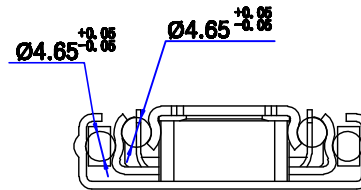

28"	700	705			
26"	650	655			
24"	600	605	10	290	277
22"	550	553	9	263	253.5
20"	500	505	8	242.5	223.5
18"	450	455	7	218	198.0
16"	400	405.5	6	195	171.6
14"	350	350	5	169.5	147.5
12"	300	303	4	145.5	122
10"	250	245	3	113	104
Size	A	B	Cage (pitch number)	Cage (mm) ±0.3	C ± 2

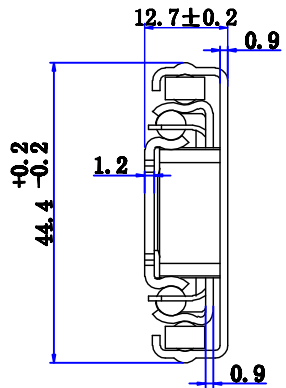
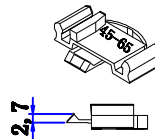

		DIMENSION CLASSIFICATION * IMPORTANT		UNIT SCALE	mm 1:1	PAPER A4	Draw Check	Peter Wen 20150907
			DIM. Tolerance	>0.5 --6 ±0.1	>30 --120 ±0.2	>120 --400 ±0.3	>400 --1000 ±0.5	

DIM.	>L5	>30	>120	>400	>1000
	--6	--120	--400	--1000	--2000
Tolerance	±0.1	±0.2	±0.3	±0.5	±1.0

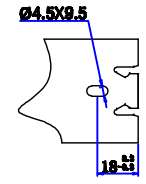

DIMENSION CLASSIFICATION	UNIT	mm	PAPER	Draw	Peter Wen 20150907
	SCALE	1:1		Check	
*			A4		

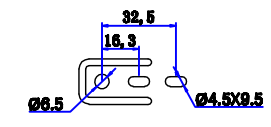

Notes,
Thickness 0.9mm, Zinc Plating

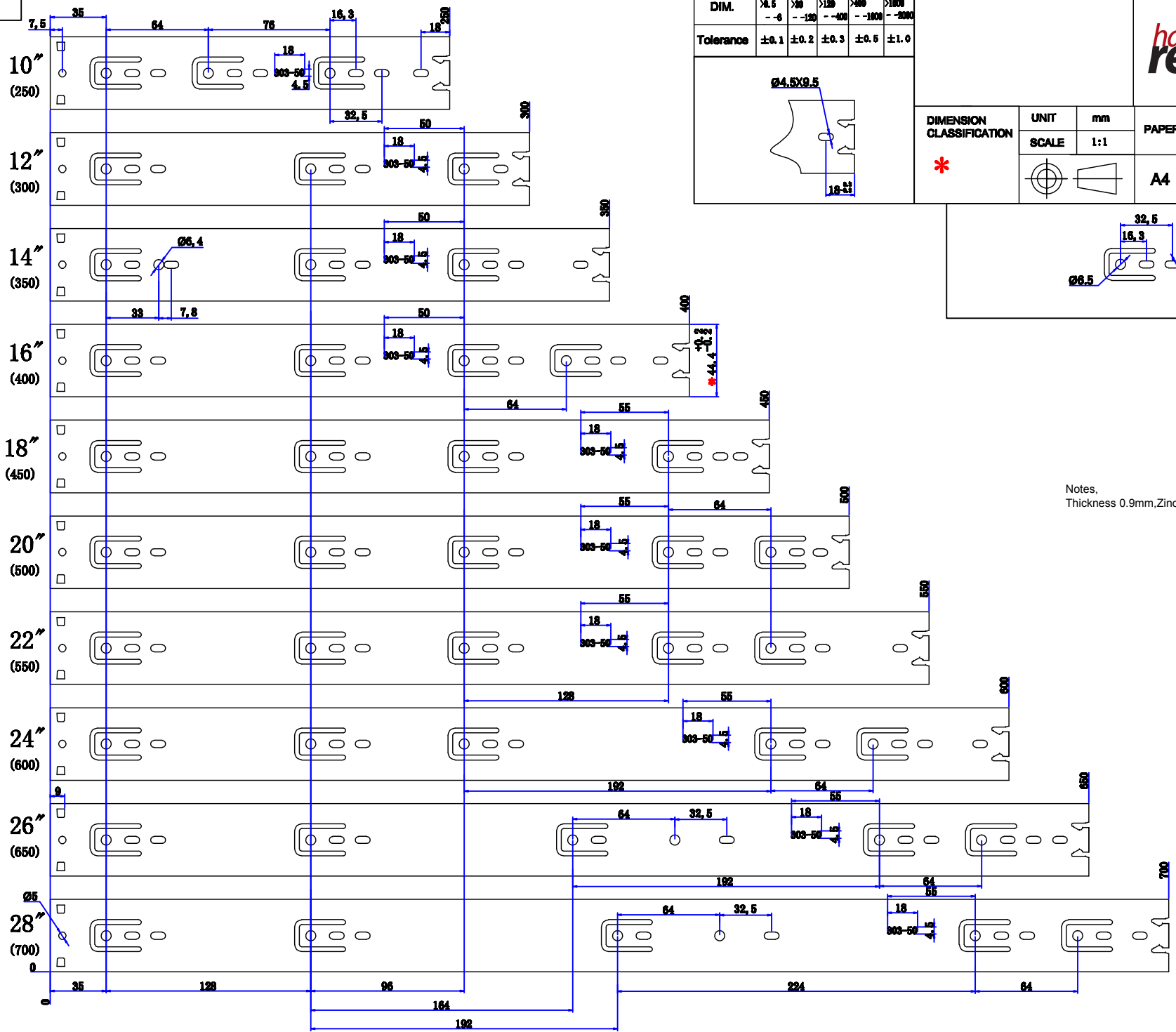
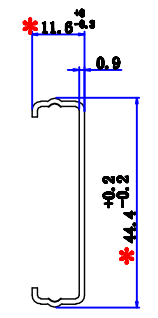

DIM.	>0.5	>30	>120	>400	>1000
	--6	--126	--400	--1000	--2000
Tolerance	±0.1	±0.2	±0.3	±0.5	±1.0

**hardware
resources**

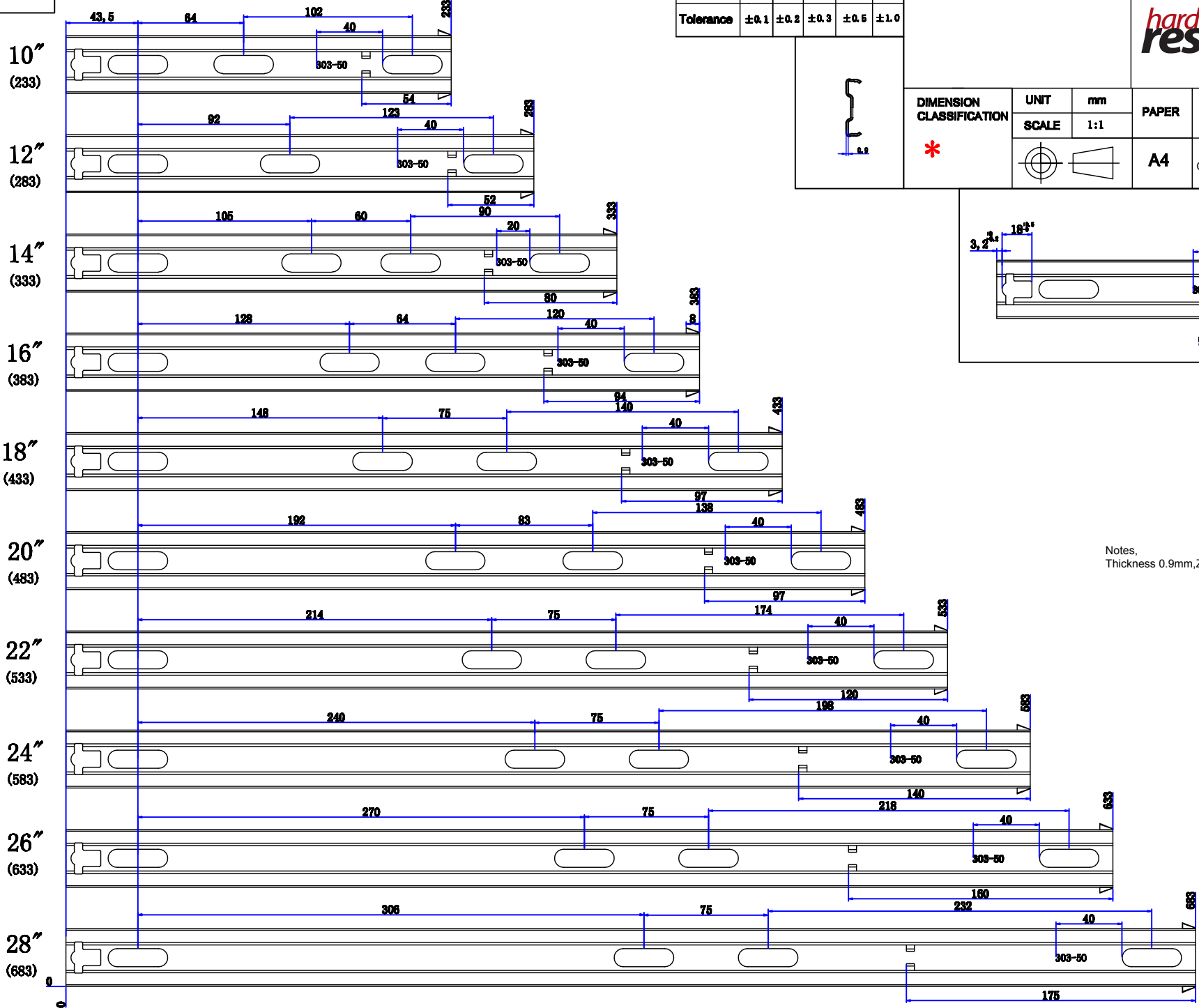
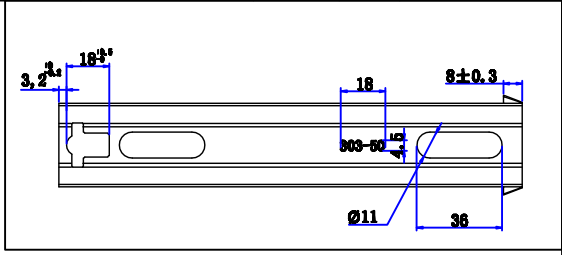
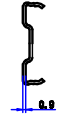

DIMENSION CLASSIFICATION	UNIT	mm	PAPER	Draw	Peter Wen 20150907
	SCALE	1:1			
*			A4	Check	



Notes,
Thickness 0.9mm, Zinc Plating

DIM.	>0.5	>30	>120	>400	>1000
	-- -6	-- -120	-- -400	-- -1000	-- -2000
Tolerance	±0.1	±0.2	±0.3	±0.5	±1.0

Notes,
Thickness 1.2mm, Zinc Plating

DIMENSION CLASSIFICATION	UNIT	mm	PAPER	Draw	Peter Wen 20150907
	* IMPORTANT	SCALE			
			A4	Check	

