

## Features

- 33-inch minimum base cabinet width.
- Single bowl.
- 9-inch depth.
- Three faucet holes.
- Bowl slopes 2 degrees toward drain to minimize water pooling.
- Offset drain increases workspace in the sink and storage space underneath.
- Includes K-6239 colander with integral cutting board and K-6237 left-hand bottom sink rack.

## Material

- KOHLER® enameled cast iron.

## Installation

- Top-mount

## Recommended Products/Accessories

K-9000 P-Trap  
K-6237 Left-Bowl Sink Rack  
K-6255 Right-Bowl Sink Rack  
K-6377 Sponge Caddy  
K-6378 Kitchen Brush Caddy  
K-6379 Kitchen Squeegee  
K-6382 Disinfecting Wipes Dispenser  
K-6383 Soap Dispenser  
K-8618 Paper Towel Holder  
K-8619 Flexible Kitchen Mat  
K-8624 Dish Scraper  
K-8801 Sink Strainer  
K-8799 Sink Strainer

## Optional Products/Accessories

K-6194 Utility Rack With Soaking Cup  
K-6246 Cutting Board

## Included Components

Product consists of:

K-6239 Colander with Cutting Board  
K-6237 Left-Bowl Sink Rack



## Codes/Standards











ASME A112.19.1/CSA B45.2

## KOHLER® Enameled Cast Iron Kitchen Sink Lifetime Limited Warranty

See website for detailed warranty information.

## Available Colors/Finishes

*Color tiles intended for reference only.*

Color	Code	Description
	0	White
	FF	Sea Salt™
	96	Biscuit
	47	Almond
	FD	Cane Sugar™
	95	Ice™ Grey
	G9	Sandbar
	K4	Cashmere
	20	Suede
	KA	Black 'n Tan
	7	Black Black™

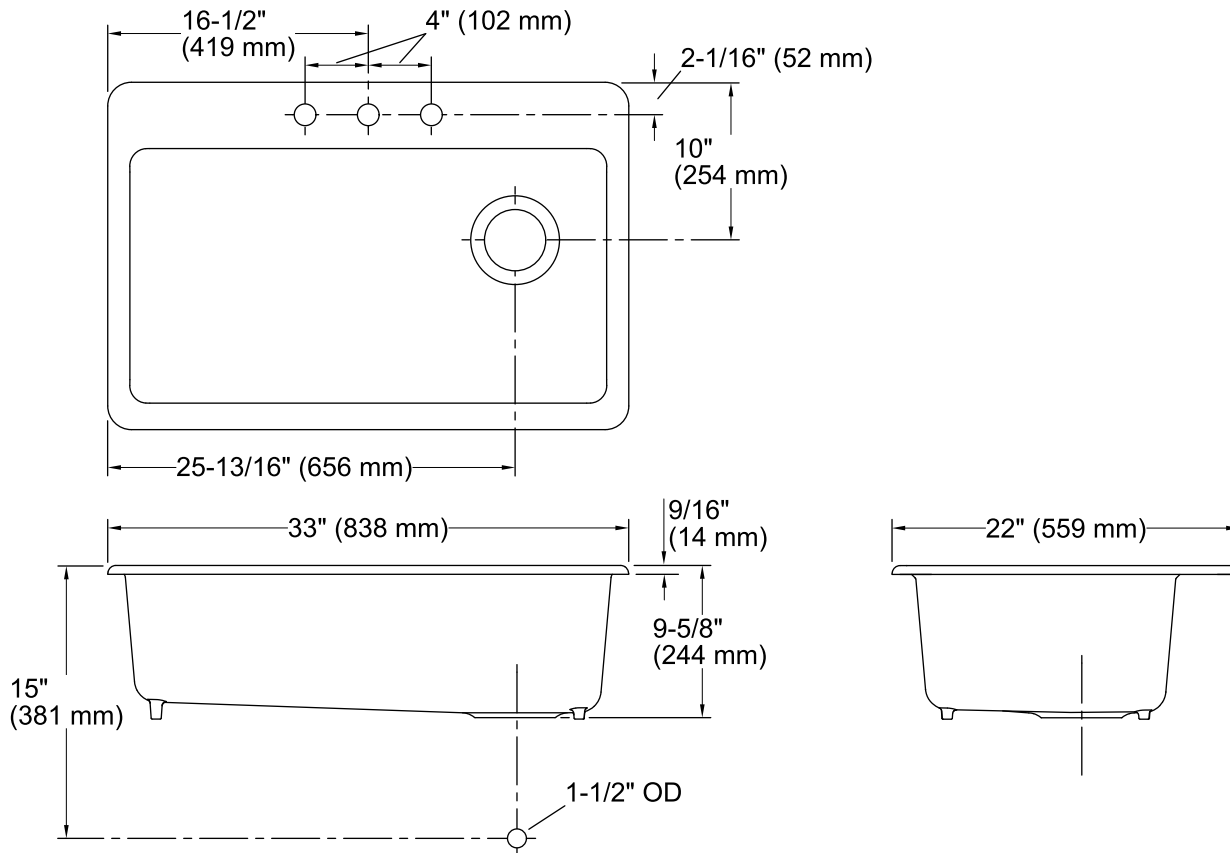

## Technical Information

All product dimensions are nominal.

Bowl configuration:	Single
Installation:	Top-mount
Min. base cabinet width:	33" (838 mm)
Bowl area (Only):	Length: 30-1/4" (768 mm) Width: 15-13/16" (402 mm) Water depth: 9" (229 mm)
Number of deck holes:	3
Faucet hole(s):	1-3/8" (35 mm)
Drain hole:	3-7/8" (98 mm)
Template:	1166727-7, required, included

## Notes

Install this product according to the installation instructions.

**NOTICE:** Countertop manufacturer or cutter must use the cut-out template provided with the product, or a current one provided by Kohler Co. (call 1-800-4-KOHLER). Kohler Co. is not responsible for cutout errors when the incorrect cut-out template is used.