

### Features

- Spacious design accommodates up to two bathers.
- Safeguard slip-resistant surface on bath floor.
- End drain.
- Under-mountable

### Material

- KOHLER® enameled cast iron.

### Installation

- Drop-in or under-mount.

### Additional Hydrotherapy Options

- Soaking Bath - K-855-0
- Whirlpool - K-856-H2
- Whirlpool Massage Package - K-856-M
- Effervescence Relax Package - K-856-CT
- Effervescence Spa Package - K-856-AH
- Spa Package + Massage Package - K-856-V

### Required Products/Accessories

K-7147-AF 1-1/2" Contoured Pop-up Drain

### Recommended Products/Accessories

K-587 Under-Mount Installation Kit



### Codes/Standards

ASME A112.19.1/CSA B45.2













ASTM F462

### KOHLER® Enameled Cast Iron Bath and Shower Base Lifetime Limited Warranty

See website for detailed warranty information.

### Available Colors/Finishes

*Color tiles intended for reference only.*

Color	Code	Description
	0	White
	96	Biscuit
	47	Almond
	NY	Dune
	95	Ice™ Grey
	G9	Sandbar
	33	Mexican Sand™
	K4	Cashmere
	58	Thunder™ Grey
	7	Black Black™
	GRL	Grey Lavender
	DGB	Indigo Blue
	PLM	Black Plum

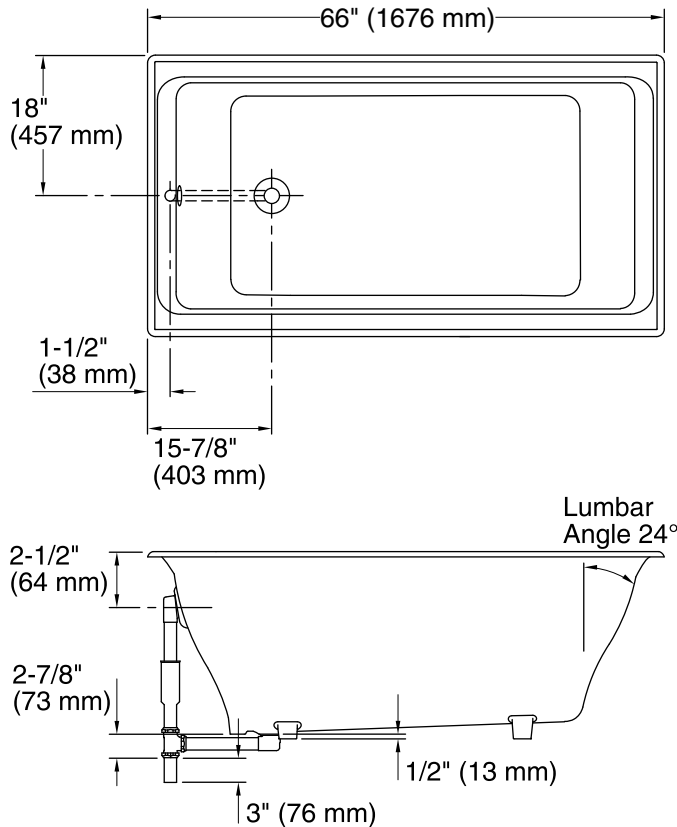

No change in measurements if connected with drain illustrated. (K-7147-AF)

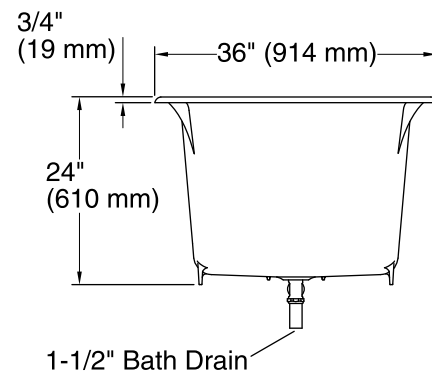

### Technical Information

All product dimensions are nominal.

Installation:	Drop-in, Under-mount
Drain location:	End
Basin area, bottom:	45" x 25" (1143 mm x 635 mm)
Basin area, top:	58" x 29" (1473 mm x 737 mm)
Weight:	440 lbs (199.6 kg)
Minimum floor load:	81 lbs/ft <sup>2</sup> (395.5 kg/m <sup>2</sup> )
Water depth:	19-1/2" (495 mm)
Water capacity:	105 gal (397.5 L)
Cutout:	Drop-in, 64-1/2" x 34-1/2" (1638 mm x 876 mm)
Template:	Under-mount, K-587, required, not included
Minimum flat for door:	1-13/16" (46 mm)

### Notes

Measure your actual product for rough-in details. Install this product according to the installation instructions.

The hot water supply should be 70% of the capacity of the bath or greater. Installations will vary.

Kit is required for under-mount installations (sold separately).