

### Features

- Low-threshold design for easy entry and exit.
- Recessed rear drain.
- Single threshold for three-wall or alcove installation.
- Durable acrylic construction.
- Requires K-9333 Groove aluminum drain cover or K-9337 Groove teak drain cover (sold separately).

### Required Products/Accessories

K-9333 Drain Cover

or

K-9337 Drain Cover

### Recommended Products/Accessories

K-9132 Shower Drain



### Codes/Standards

CSA B45.5/IAPMO Z124

ASTM E162







ASTM E662

### KOHLER® Plastic Baths and Receptors Lifetime Limited Warranty

See website for detailed warranty information.

### Available Colors/Finishes

*Color tiles intended for reference only.*

Color	Code	Description
	0	White
	96	Biscuit
	47	Almond
	NY	Dune
	95	Ice™ Grey
	G9	Sandbar

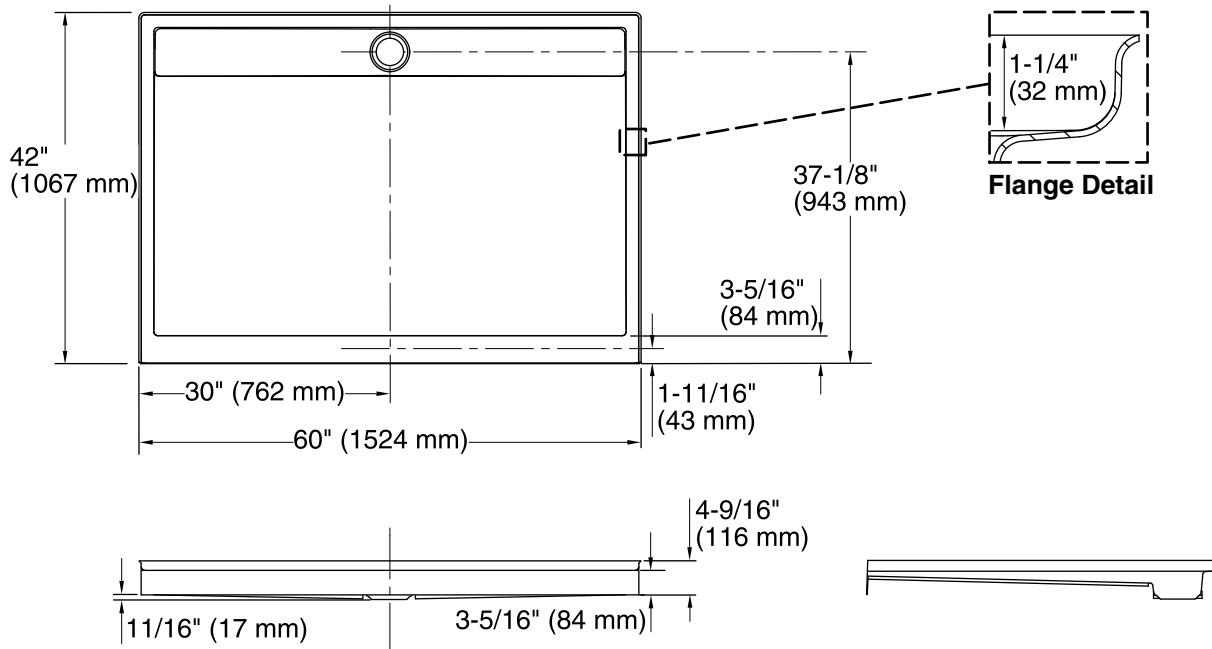

### Technical Information

All product dimensions are nominal.

- Installation: Three-wall alcove
- Drain location: Center rear
- Weight: 72 lbs (32.7 kg)
- Minimum floor load: 20 lbs/ft<sup>2</sup> (97.6 kg/m<sup>2</sup>)

### Notes

- Measure your actual product for rough-in details.
- Install this product according to the installation instructions.
- Shimming may be required to level the fixture.
- Shimming may be required between the stud frame and the fixture.
- Stud opening tolerance is + 1/4" (6 mm), - 0" (0 mm).