



## Underscore® Rectangle

5' Bath  
K-1957-LA

### Features

- Integral flange.
- Left drain.
- Slotted overflow for deep soaking.
- Integral lumbar support.
- Integral apron.
- Above-the-floor drain installation.
- Textured bottom surface.
- 60" (1524 mm) x 32" (813 mm) x 21" (533 mm).

### Material

- Acrylic.

### Installation

- Alcove.

### Required Accessories

- K-7271 Brass Slotted Overflow Bath Drain
- K-7272 PVC Slotted Overflow Bath Drain



### Codes/Standards











CSA B45.5/IAPMO Z124  
ASTM E162  
ASTM E662  
CARB P2

### KOHLER® One-Year Limited Warranty

See website for detailed warranty information.

### Available Color/Finishes

*Color tiles intended for reference only.*

Color	Code	Description
	0	White
	96	Biscuit
	47	Almond
	NY	Dune
	95	Ice™ Grey
	G9	Sandbar
	33	Mexican Sand™
	K4	Cashmere
	58	Thunder™ Grey
	7	Black Black™

USA/Canada: 1-800-4KOHLER (1-800-456-4537)

Kohler Co. reserves the right to make revisions without notice to product specifications.

For the most current Specification Sheet, go to [www.kohler.com](http://www.kohler.com).

2-12-2018 03:47

THE BOLD LOOK  
OF **KOHLER**®

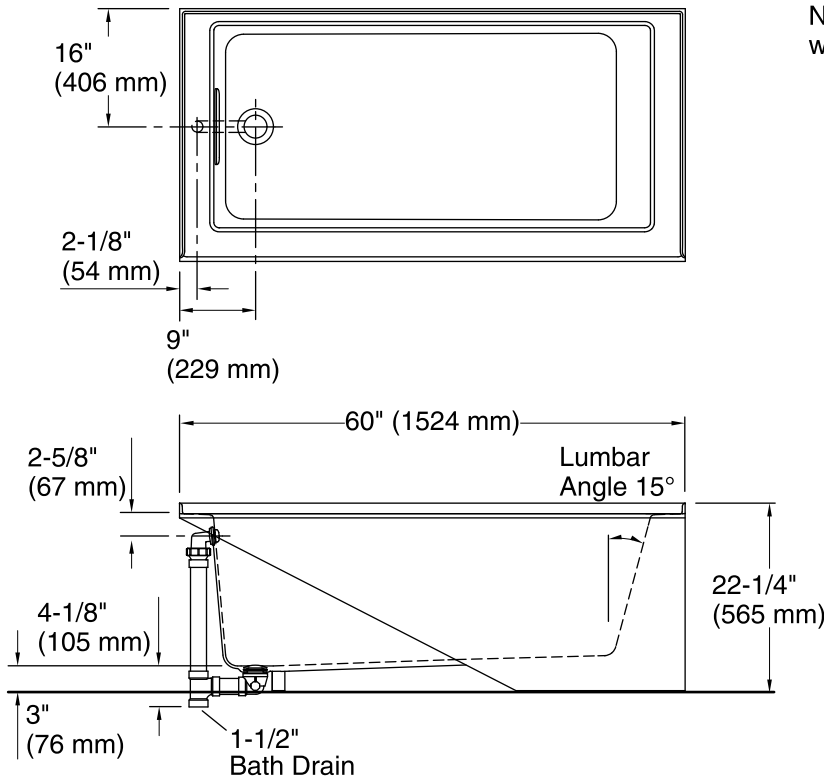

No change in measurements if connected with drain illustrated. (K-7272)

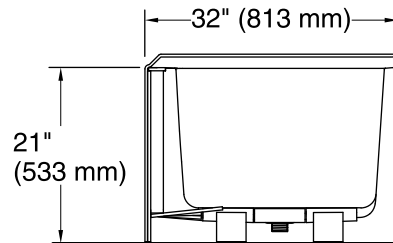
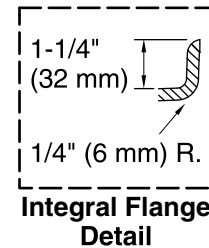

### Technical Information

All product dimensions are nominal.

Installation:	3-Wall Alcove
Drain location:	Left
Basin area, bottom:	46-1/4" x 22" (1175 mm x 559 mm)
Basin area, top:	52" x 24" (1321 mm x 610 mm)
Weight:	105 lbs (47.6 kg)
Minimum floor load:	56 lbs/ft <sup>2</sup> (273.4 kg/m <sup>2</sup> )
Water depth:	15-1/2" (394 mm)
Water capacity:	68 gal (257.4 L)
Minimum flat for door:	2-3/4" (70 mm)

### Notes

Measure your actual product for rough-in details.

Install this product according to the installation instructions.

The hot water supply should be 70% of the capacity of the bath or greater. Installations will vary.