

TRADITIONAL GANTRY PULLDOWN FAUCET / 12" ARTICULATED SPOUT

4410-12

- Max Counter Thickness 2-3/8"
- Minimum Install Hole Size 1-3/8"

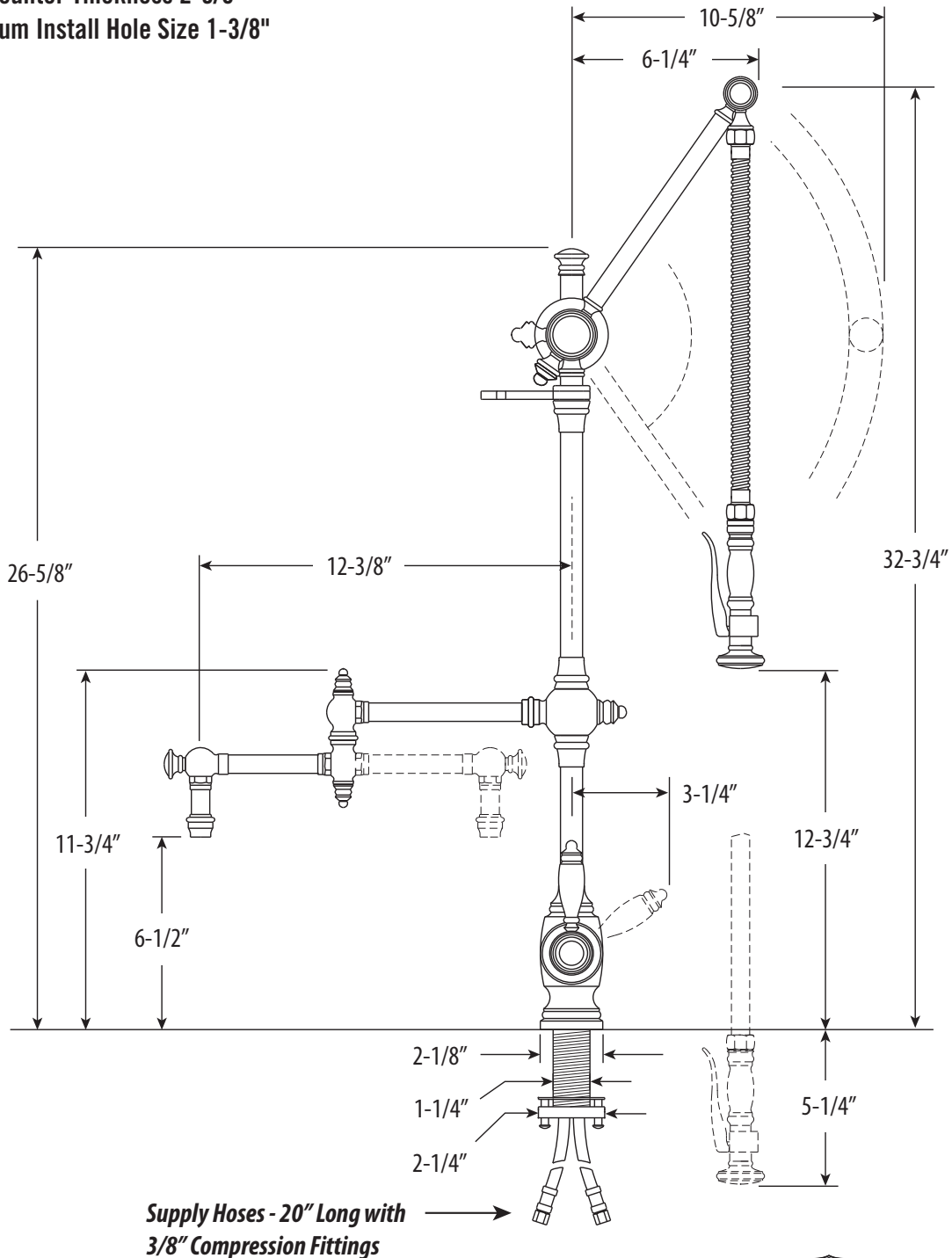

DIMENSIONS MAY VARY AND ARE SUBJECT TO CHANGE. NO RESPONSIBILITY IS ASSUMED FOR USE OF SUPERCEDED OR VOIDED DATA